

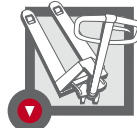

FORKLIFT
DIVISION



PARTS
DIVISION



HANDLING
EQUIPMENT
DIVISION



RENTAL
EQUIPMENT
DIVISION



SERVICE &
REPAIR
DIVISION

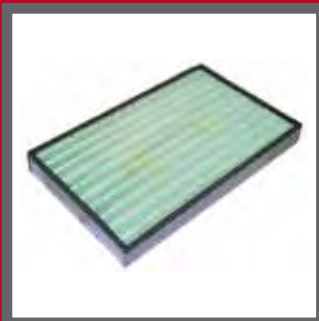

REF 7543353

TOTAL SOURCE[®]
Parts and Accessories

FILTERS: QUICK SEARCH



PARTS DIVISION

TVH FORKLIFT PARTS nv • BRABANTSTRAAT 15 • 8790 WAREGEM • BELGIUM
TEL +32 56 43 42 11 • FAX +32 56 43 44 88 • E-MAIL parts@tvh.com • WEB www.tvh.com



- ▶ De onderdelen vermeld in deze lijst, zijn normaal uit voorraad leverbaar, behoudens uitverkocht. Ook niet vermelde onderdelen kunnen binnen de kortste tijd uitgeleverd worden. De O.E.M. referenties dienen enkel ter indicatie en impliceren niet dat deze van de vermelde heftruckconstructeur afkomstig zijn. Deze onderdelenlijst kan zonder enige voorafgaande verwittiging aangepast worden. Alle gebruikte foto's, tekeningen, afbeeldingen, merknamen, omschrijvingen en nummers dienen alleen ter identificatie.
- ▶ Les pièces de rechange, mentionnées dans cette liste, sont normalement livrables du stock. En plus, les articles non-indiqués peuvent être fournis en peu de temps. Cette liste peut être modifiée sans avis préalable. Les références O.E.M. sont seulement indicatives et n'impliquent pas que les pièces de rechange viennent du constructeur de chariots élévateurs. Toutes les photographies, illustrations, marques, descriptions, tous les plans et numéros servent exclusivement à une identification.
- ▶ Die in dieser Liste aufgeführten Teile sind normalerweise aus dem Lager lieferbar. Wir sind zudem in der Lage nicht aufgeführte Teile innerhalb kürzester Zeit zu liefern. Die O.E.M. Referenznummern dienen zur Information und beinhalten nicht, dass diese vom genannten Gabelstaplerhersteller kommen. Diese Bestandsliste kann ohne vorhergehende Ankündigung geändert werden. Alle verwendeten Foto's, Zeichnungen, Abbildungen, Markennamen, Beschreibungen und Nummern dienen nur zu Identifikationszwecken.
- ▶ The spare parts mentioned in this list can normally be delivered from stock. In addition, we can supply parts, which are not mentioned in this catalogue, with the shortest possible delivery time. The O.E.M. references are only for indication purposes and do not imply that the spare parts are coming from the forklift manufacturer. This spare parts list can be modified without prior notice. All photographs, drawings, illustrations, brand names, descriptions and numbers are included for identification purposes only.
- ▶ I pezzi di ricambio, menzionati in questo listino, possono essere forniti di consegna immediata a condizione che non sono esauriti. Pezzi di ricambio non menzionati possono essere forniti in poco tempo. Le referenze O.E.M. sono solamente indicative e non implicano che i pezzi di ricambio vengono di questo costruttore di carrelli elevatori. Questa lista ricambi può essere aggiornata senza avvisi anticipati. Tutti i numeri, codici, nomi, foto, spaccati e disegni sono solo a titolo informativo.
- ▶ Normalmente tenemos en almacén las piezas de recambio mencionadas en esta lista microfichera. Tenemos la posibilidad de suministrar las piezas de recambio no mencionadas. Los números de referencia O.E.M. sirven solamente como indicación y no implican que vienen del constructor de las carretillas elevadores. La lista de almacén puede ser adaptada sin aviso anterior. Todas las fotos, despieces, nombres de marca, descripciones y números sólo sirven para identificación.

© Copyright by TVH FORKLIFT PARTS - BELGIUM 2004

All the information contained in this catalogue remains the property of TVH Forklift Parts and may not be copied, reproduced, transmitted or communicated by any other ways to third parties without a prior written permission.

- All photographs, illustrations, brand names and part numbers are included for identification purposes only.
- OEM references are purely indicative and do not imply that parts originate from the forklift manufacturer.
- Products that do not comply with regulatory requirements concerning CE conformity are not placed on the market in the European Economic Area.
- Printing errors reserved

In the catalogue of TVH, company and/or personal details are collected from forms. When you provide us with such information, it is stored in the files of TVH. You have the right to access and, if necessary, correct your company and/or personal data, according to the applicable law. The databases containing your information are protected against unauthorized access. The information collected is not transmitted to third parties.



For all our latest catalogue updates and company info: www.tvh.be

INDEX

	page
TECHNICAL DETAIL: FILTER	3
FILTER TYPES	4 - 8
FILTERS & ACCESSORIES	9 -16
FILTER KITS	17-18

QUICK SEARCH FILTER GUIDE

used for:

• CATERPILLAR	19
• CLARK	23
• DAEWOO	41
• FIAT	47
• HALLA	53
• HYSTER	57
• KOMATSU	67
• LINDE	79
• MANITOU	87
• MITSUBISHI	117
• NISSAN	135
• SAMSUNG	145
• STILL	149
• TCM	155
• TOYOTA	167
• YALE	187

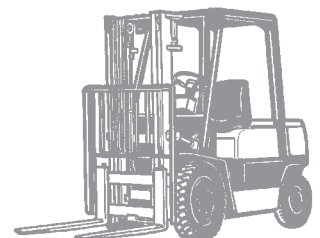



For all our latest catalogue updates and company info: www.tvh.be



- AC DELCO - AIR REFINER -
- ALGAS - ALLIS -
- CHALMERS - AMEISE -
- AMC - ARGO - ARLON -
- ATLET - AUDUREAU -
- BAKER - BALDWIN -
- BALKANCAR - BOBCAT -
- BOSCH - BRUNILIFT - BT
- BV TRANSPALLET -
- CATERPILLAR - CAV -
- CLARK - CLEAN -
- CONTINENTAL -
- COOPERS - COVENTRY -
- CROSLAND - CROWN -
- CUMMINS - DAF - DESTA
- DEUTZ -
- DONALDSON -
- FANTUZZI - FARR -
- FENDT - FENWICK -
- FIAAM - FIAT -
- FLEETGUARD - FORD -
- FRAM FILTERS - HEDEN -
- HENGST - HENLEY -
- HINO - HYSTER - ISUZU
- JUNGHEINRICH -
- KALMAR - KENTRUCK -
- KNECHT - KOMATSU -
- KUBOTA - LANCER -
- BOSS - LANSING - LINDE
- LUBERFINER - LUGLI -
- M.A.N. - MAHLE MANI-
- TOU -
- MANN & HUMMEL -
- MASSEY FERGUSON -
- MAZDA - MERCEDES -
- MERLO - MIC -
- MITSUBISHI - MORA -
- MOTORCRAFT -
- NIPPON-DENSO -
- NISSAN - NYK -NICHYU
- PEACOCK - PEG -
- PERKINS -
- PEUGEOT - PURFLUX -
- PUROLATOR - RENAULT
- ROLLS ROYCE - SALEV
- SAXBY - STEINBOCK -
- STILL - SVETRUCK -
- TCM - TECHNOCAR -
- TENNANT - TOYOTA -
- UCC - UFI FILTER - UNI-
- TRAC - VALMET - VOLVO
- VW -
- WAUKESHA - WIN - WIX
- WOODGATE - YALE -
- YANMAR - ZEPHIR -
- ZETOR - ZF

**Almost 3000 different types of filters
kept in stock !**

Cross referencing to more than 100 brands.

Special quantity discount for bulk orders.



For all our latest catalogue updates and company info: www.tvh.be

TECHNICAL DETAIL: FILTER



Company:

Customer code:

Name:

Fax number:

Truck make:

Truck type:

Serial nr.:

air filter oil filter fuel filter

transm. filter hydr. sump filter

breather filter hydraulic filter

- ① **TY** type of filter (see next pages / as per picture)
- ② **D1/TA** inner diameter or thread size
- ③ **D2** Outer diameter
- ④ **H** Height
- ⑤ **L1** Shortest length (only used on some versions)
- ⑥ **L2** Longest length (only used on some versions)

FILTER TYPES

MATCH FILTER HEAVY DUTY FORKLIFT FILTERS

For all our latest catalogue updates and company info: www.tvh.be

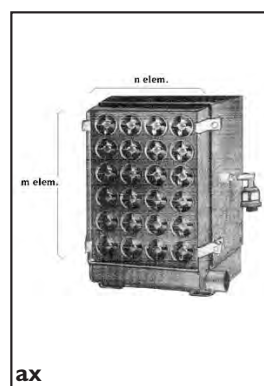
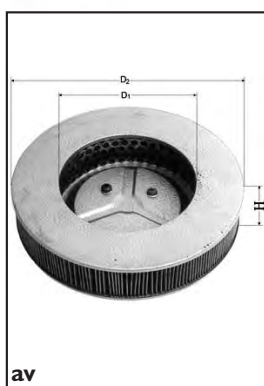
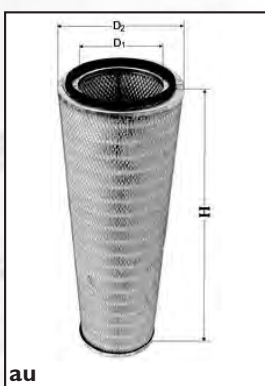
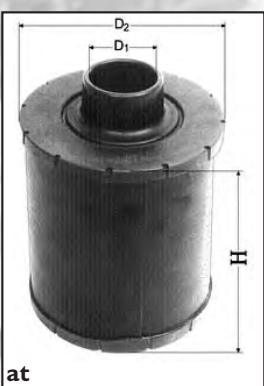
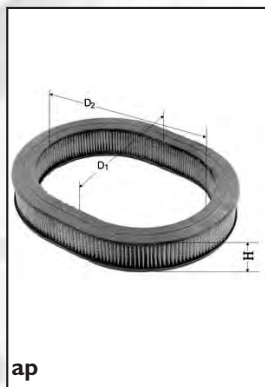
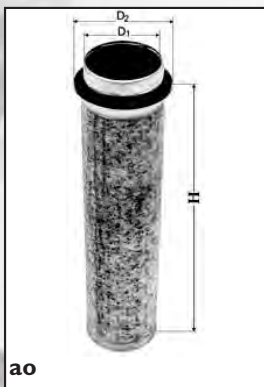
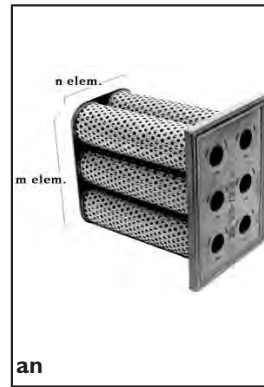
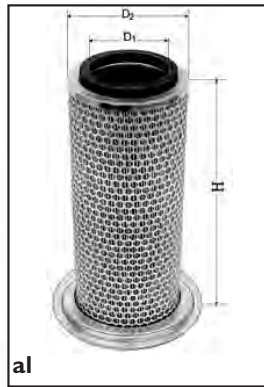
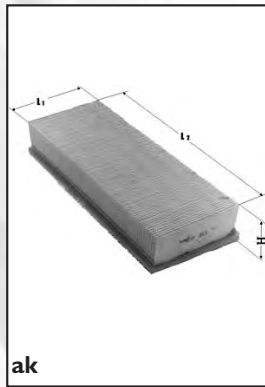
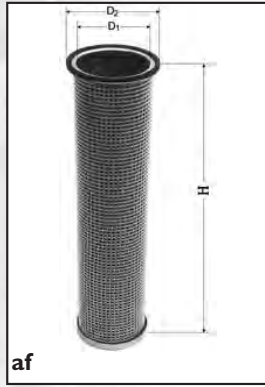
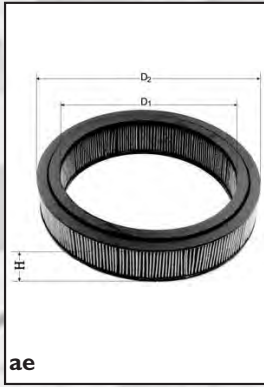
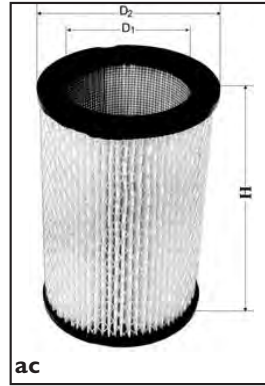
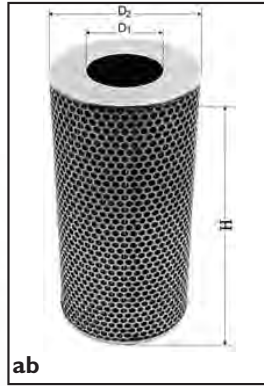

FILTER TYPES

MATCH FILTER HEAVY DUTY FORKLIFT FILTERS

For all our latest catalogue updates and company info: www.tvh.be



ay



az



b



ba



bb



bc

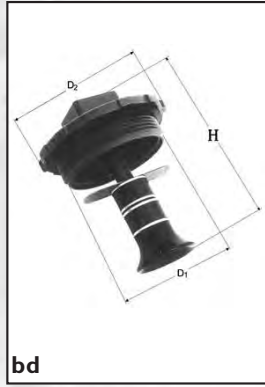

bd

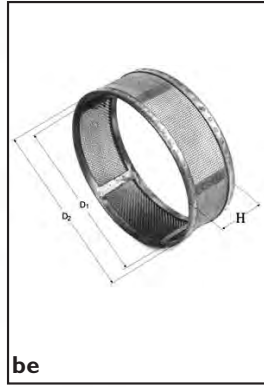

be

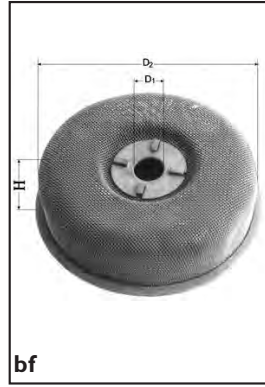

bf

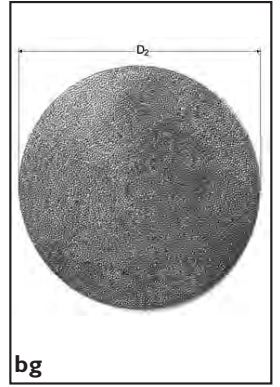

bg

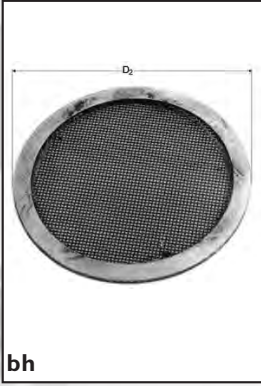

bh



bi

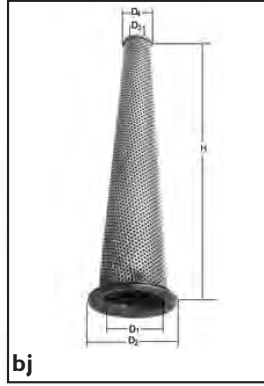

bj

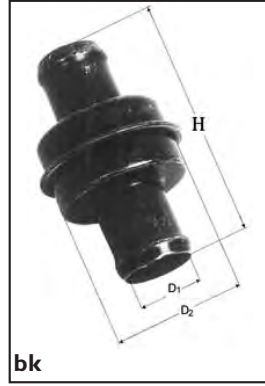

bk



bl

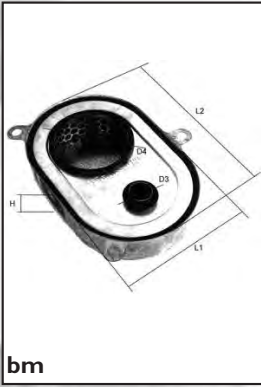

bm

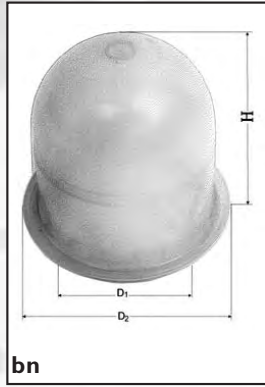

bn

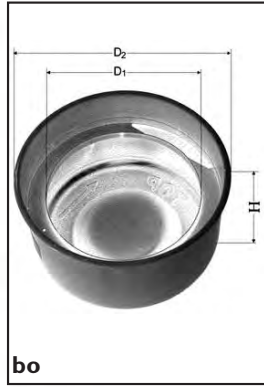

bo

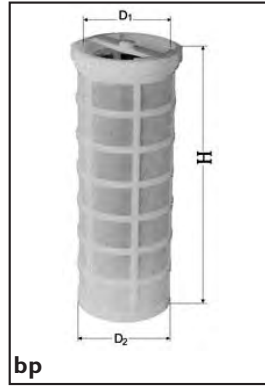

bp



bq



br



bs



bt



bu



bv

FILTER TYPES

MATCH FILTER
HEAVY DUTY FORKLIFT FILTERS

For all our latest catalogue updates and company info: www.tvh.be

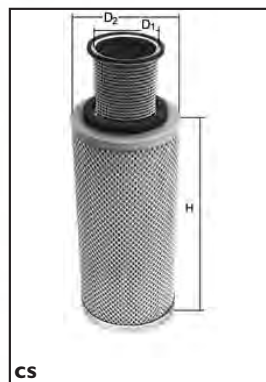
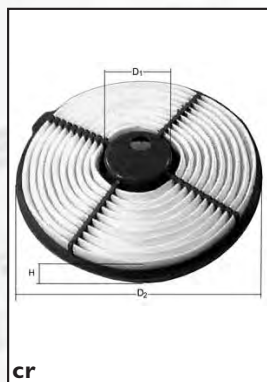
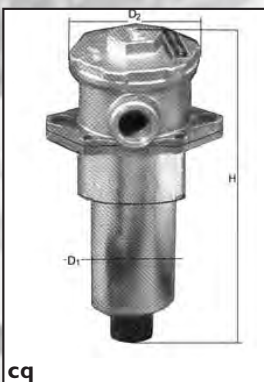
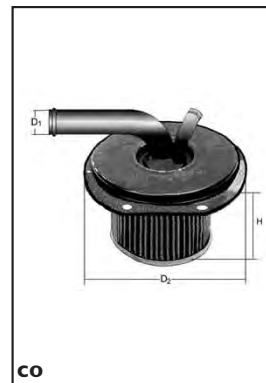
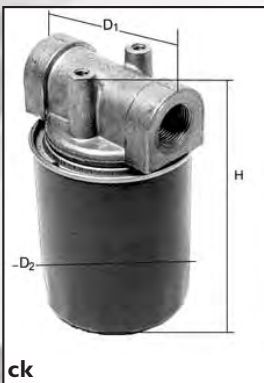
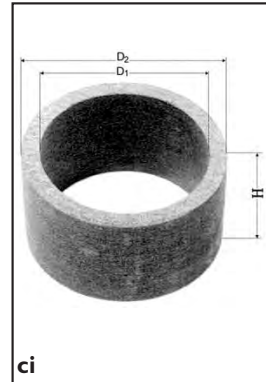
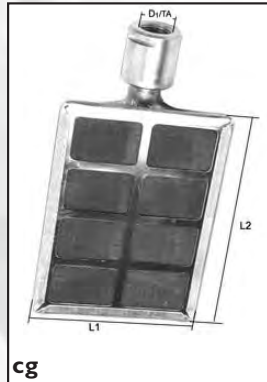
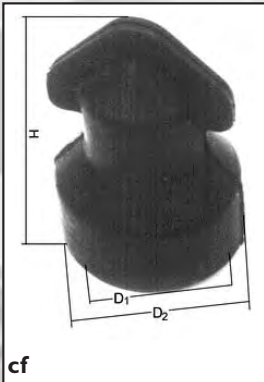
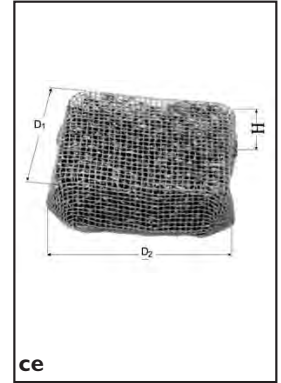
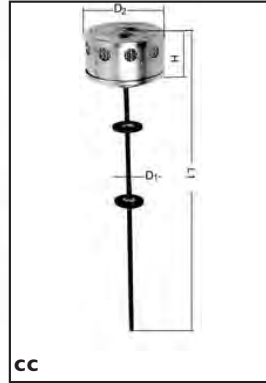
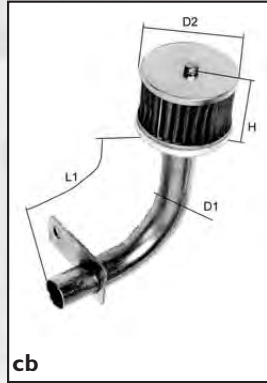
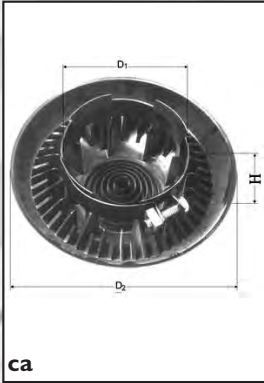
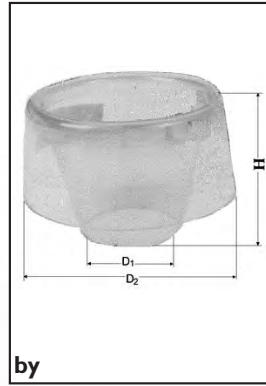

FILTER TYPES

MATCH FILTER HEAVY DUTY FORKLIFT FILTERS

For all our latest catalogue updates and company info: www.tvh.be



cy

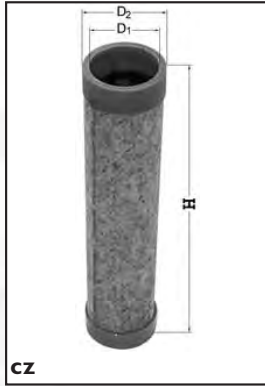

cz

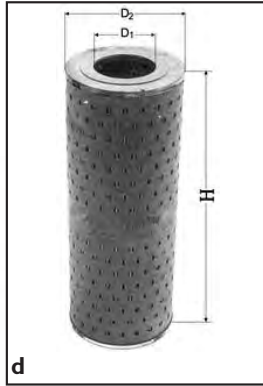

d

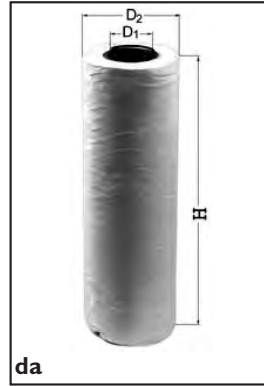

da



db

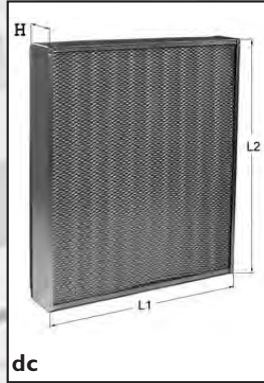

dc



dd



de

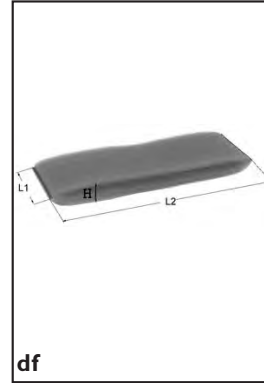

df



dh

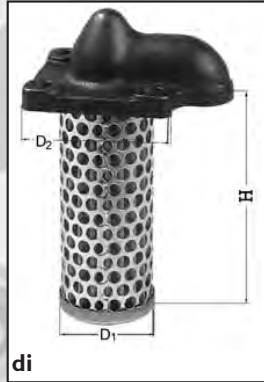

di



dj

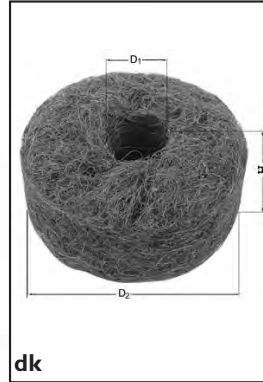

dk

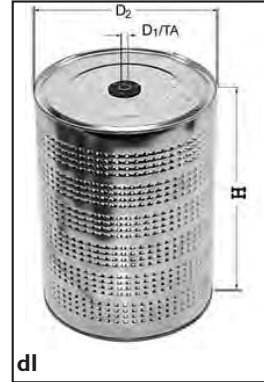

dl



dm



do

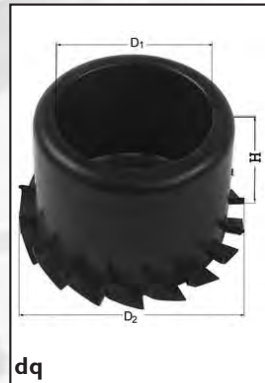

dq



dr

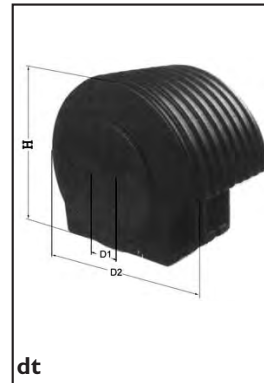

dt

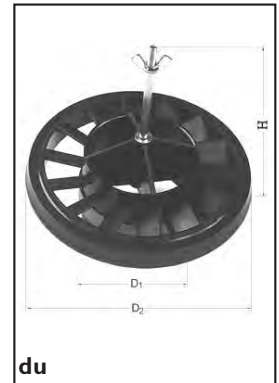

du

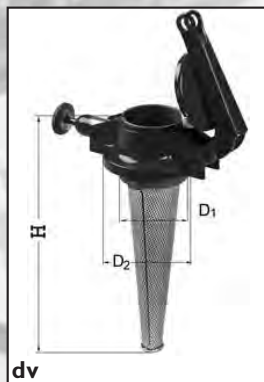

dv

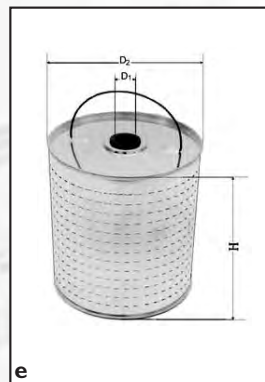

e

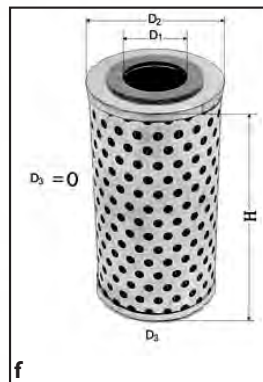

f

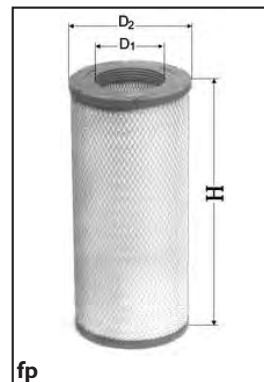

fp

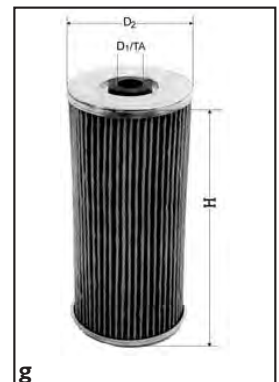

g

FILTER TYPES

MATCH FILTER HEAVY DUTY FORKLIFT FILTERS

For all our latest catalogue updates and company info: www.tvh.be

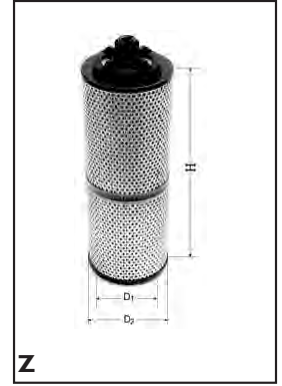
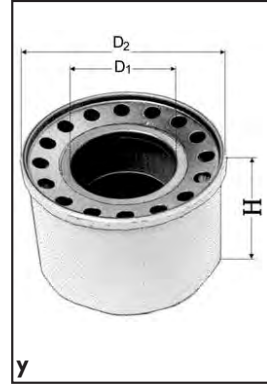
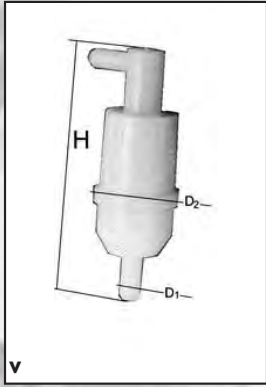
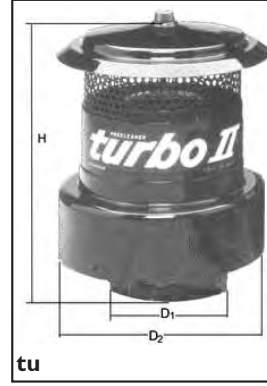
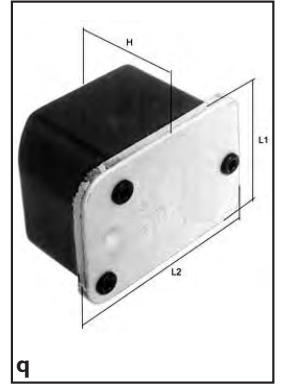
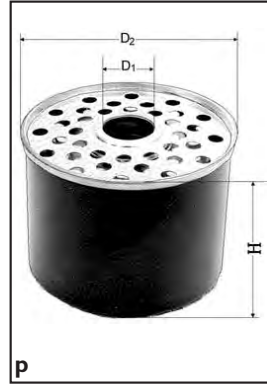
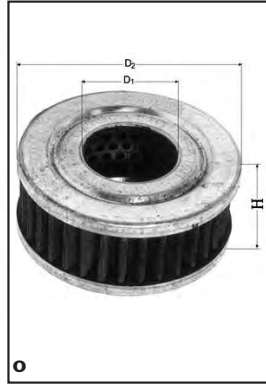
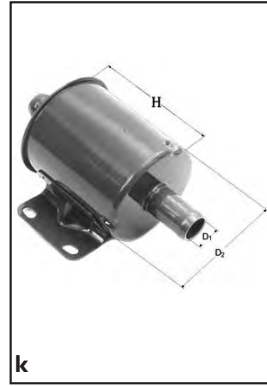
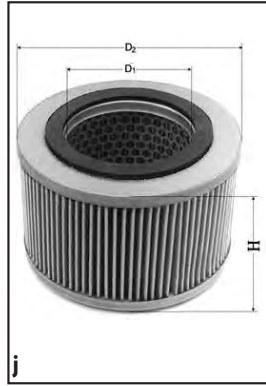
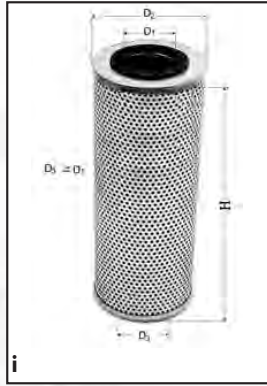
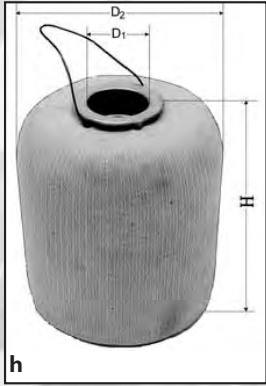



FILTERS

MATCH FILTER HEAVY DUTY FORKLIFT FILTERS



For all our latest catalogue updates and company info: www.tvh.be

USED FOR: TOYOTA

D = outer dia.
d = inner dia.
H = total height

REF./ 105TA4806
outer air filter



D=138 mm
d=84 mm
H=275 mm

for inner use
REF./ 105TA4807

USED FOR: TOYOTA

REF./ 105TA4807
inner air filter

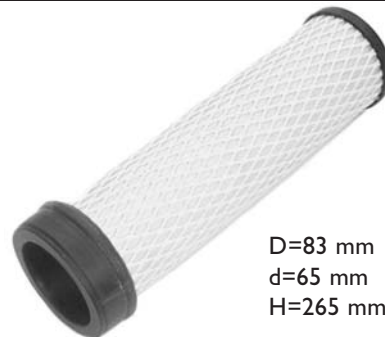

D=83 mm
d=65 mm
H=265 mm

for outer use
REF./ 105TA4806

USED FOR: HYSTER

REF./ 105TA4814
hydraulic filter with
10 micron element



D = 94 mm
d = 27 mm
H = 160 mm

USED FOR: NISSAN

REF./ 106TA6809
LPG-filter



D = 22 mm
d = 10 mm
H = 52 mm

USED FOR: MITSUBISHI

REF./ 106TA6810
LPG-filter



D = 24 mm
d = 15 mm
H = 50 mm

This is just a selection of filters.
Other types available.

USED FOR: MITSUBISHI

REF./ 106TA6811
hydraulic-filter



D = 90 mm
d = 3/4 NPT
H = 167 mm

USED FOR: KOMATSU

REF./ 106TA6812
air filter



D = 137 mm
d = 67 mm
H = 275 mm

USED FOR: CLARK

REF./ 106TA6813
air filter



D = 140 mm
d = 47 mm
H = 203 mm

USED FOR: LINDE

REF./ 106TA6814
transmission filter



D = 85 mm
d = 3/4 UNF
H = 150 mm

USED FOR: CLARK

REF./ 105TA4813
transmission filter



D = 97 mm
d = 2" UNF
H = 178 mm



For all our latest catalogue updates and company info: www.tvh.be

USED FOR: TOYOTA

D = outer dia.
d = inner dia.
H = total height



REF./ 106TA6943

Hydraulic filter

D = 108 mm
d = 27 mm
H = 120 mm

USED FOR: MITSUBISHI

REF./ 104TA8525



Fuel filter

D = 98 mm
d = M20
H = 135 mm

USED FOR: TOYOTA

REF./ 106TA6944



Fuel filter

D = 95 mm
d = 3/4 UNF
H = 131 mm

USED FOR: TOYOTA

REF./ 105TA4816



Oil filter

D = 78 mm
d = 3/4 UNF
H = 85 mm

*This is just a selection of filters.
Other types available.*

USED FOR: CATERPILLAR

REF./ 106TA6945



Air filter

D = 210 mm
d = 105 mm
H = 158 mm

for inner use:
REF./ 106TA6946

USED FOR: CATERPILLAR

REF./ 106TA6946



Air filter

D = 108 mm
d = 70 mm
H = 140 mm

for outer use:
REF./ 106TA6945

USED FOR: FIAT

REF./ 106TA6947



Air filter

D = 125 mm
d = 74 mm
H = 320 mm

for inner use:
REF./ 106TA6948

USED FOR: FIAT

REF./ 106TA6948



Air filter

D = 65 mm
d = 54 mm
H = 300 mm

for outer use:
REF./ 106TA6947

USED FOR: STILL

REF./ 106TA6949



Hydraulic filter

D = 59 mm
d = 28 mm
H = 200 mm

USED FOR: TENNANT

REF./ 106TA6950





Air filter

D = 660 mm
d = 406 mm
H = 55 mm



For all our latest catalogue updates and company info: www.tvh.be

AIR FILTERS

 <p>kit</p>  <p>element</p>	Type		Reference
	2 x 3	Kit Element Venturi	104TA8540 104TA8527 106TA2957
	3 x 3	Kit Element Venturi	104TA8542 104TA8530 107TA1742
	3 x 4	Kit Element	104TA8543 106TA2959
	4 x 4	Kit Element	104TA8544 104TA8533
	4 x 5	Kit Element	104TA8545 106TA2960
	2 x 8	Kit Element	104TA8541 106TA2961
	4 x 8	Kit Element	104TA8546 106TA2962

PRE-FILTERS

<p>complete unit</p>  <p>lid only</p>  <p>glass only</p> 	Dimensions			REF./ complete unit	REF./ lid only	REF./ glass only
	D	d	h			
	142	51	118	104TA7814	107TA1740	106TA2949
	142	51	134	106TA2956	107TA1740	106TA2949
	152	52	108	104TA7817	107TA1740	106TA2949
	174	51	147	104TA7819	107TA1740	106TA2949
	176	64	133	104TA7820	107TA1741	106TA2950
	186	64	157	104TA7821	107TA1741	106TA2950
	186	76	155	104TA7822	107TA1741	106TA2950
	187	51	158	104TA7824	107TA1741	106TA2950
	270	77	195	104TA7831	106TA2954	106TA2951
	270	92	190	104TA7832	106TA2955	106TA2951
270	102	195	104TA7829	106TA2954	106TA2951	



For all our latest catalogue updates and company info: www.tvh.be

FILTERS FOR BIG FUEL TANKS (PETROL AND DIESEL)

REF./ 107TA1749

= Filter 40 L/min.

Element = **REF./ 106TA2978**

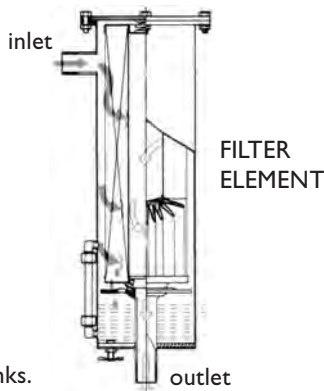

REF./ 107TA1750

= Filter 100 L/min.

Element = **REF./ 106TA2980**

This is a filter for big fuel tanks. It separates water from the fuel and it removes the contaminants from the tank.

COMPLETE FUEL FILTER CAV



REF./ 106TA2975

4 connections: 1/2 UNF

Element: **REF./ 106TA2976**

FUEL FILTER

	Ø 8mm	REF. 106TA2974	(Gasoline)
	Ø 8mm	REF. 105TA4812	(Diesel)
	Ø 6mm	REF. 104TA8113	(Gasoline)
	Ø 8mm	REF. 106TA2972	(Diesel)
	Ø 10mm	REF. 107TA1748	(Diesel)

CARTER PLUGS

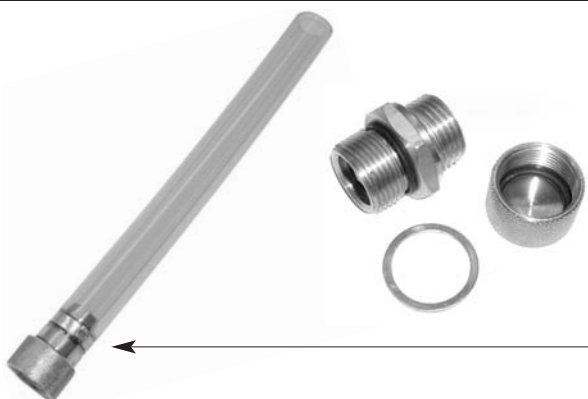

The quick service solution.

- M20 x 1,0
- M24 x 1,5
- 3/4" UNF x 16
- 1" UNF x 12
- 3/8" BSP x 19
- 1/2" BSP x 14
- 1/4" NPT x 18
- 1/2" NPT x 14

- REF./ 107TA7669**
- REF./ 106TA2963**
- REF./ 107TA1743**
- REF./ 106TA2965**
- REF./ 106TA2966**
- REF./ 107TA1744**
- REF./ 107TA1745**
- REF./ 107TA1746**

- Oil change hose (small)
- Oil change hose (large)

- REF./ 107TA1747**
- REF./ 106TA2971**

HOW DOES THE PLUG WORK ?

From now on, the normal carter stop will be replaced by the carter plug, fitted with a dust cap that stops dust and dirt from entering the line.

CHANGING OIL:

Remove the dust cap and screw the drain and hose on the carter plug. This will automatically open a valve in the plug and the oil will flow through the hose.



For all our latest catalogue updates and company info: www.tvh.be

FILTER REMOVAL TOOL



REF./ 105TA2779

FILTER REMOVAL TOOL



REF./ 105TA2781

FILTER REMOVAL TOOL



REF./ 105TA2782
Small version

FILTER REMOVAL TOOL



REF./ 105TA2780
Large version

OIL PAN



REF./ 105TA2777
capacity 15L
with rounded edge; with 3 handgrips inlet
and outlet can be shut off

OIL PAN



REF./ 105TA2778
oil pan on wheels
capacity 50L



For all our latest catalogue updates and company info: www.tvh.be

AIR PURIFIER

How the Turbo Precleaner works:

- 1) The Turbo II pre-cleaner has a specially designed blade that causes the incoming air to spin.
- 2) As the air spins, the centrifugal force separates dust, dirt, insects, rain and snow from clean air.
- 3) Contaminants are blown out special discharge ports by a high velocity, air powered rotor.
- 4) Only the purified air goes to the air filter

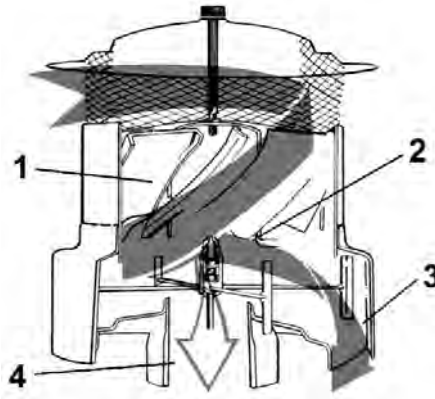

TURBO III



- Durable glass-filled nylon construction.
- Smaller and lighter.

Type: 2"
REF./ 109TA5987

- outer dia.: 134 mm
- inner dia.: 52,3 mm
- height: 130 mm

Type: 3"
REF./ 109TA5988

- outer dia.: 190 mm
- inner dia.: 77,5 mm
- height: 203 mm

REFERENCE	TYPE	DIESEL KW	PETROL/LPG KW	FIXING DIAMETER
106TA2981	13	18-37	22-51	50-76
105TA4809	24	35-92	48-125	50-76
106TA2982	35	88-132	118-177	76-114
107TA1751	46-4 1/2"	118-258	162-353	101-114
107TA1752	46-5"	118-258	162-353	127
106TA2985	46-6"	118-258	162-353	152
106TA2986	68-6"	220-405	295-552	152
107TA1753	68-7"	220-405	295-552	177
106TA2988	68-8"	220-405	295-552	203

special quantity discounts



dynamic air filters

Save fuel, time, money, air filters and engines.

Turbo II Pre-cleaners remove up to 98+% of all air contaminants including dust, powder, insects, rain and snow. Eliminating dirt and debris from intake air, ahead of the air filter, keeps your engine running at maximum power and efficiency.

Turbo II Pre-cleaners remove 50% more dust and dirt than most original pre-cleaners.

Cleaner air means extended filter life, cleaner oil means reduced engine wear and improved performance. Engine maintenance costs and down time is greatly reduced.

Turbo II Pre-cleaners are self-powered and self-cleaning requiring virtually no maintenance.

All Turbo II Pre-cleaners carry a full one year conditional warranty, with the intake air powered rotor (or spinner assembly) guaranteed for the useable life of the unit.



For long life - maximum power

This filter purifies 99%, dust, insects, rain or snow...the turbo filter reduces damage and wear.



For all our latest catalogue updates and company info: www.tvh.be

WATER ELIMINATORS



REF./ 106TA2990 (=2 pieces)
Large type

REF./ 107TA1754 (=10 pieces)
Large type



REF./ 106TA2989 (=2 pieces)
Small type

The water eliminator consists of a cylindrical cartridge, which is lined with a nylon mesh filter. The cartridge contains a small measure of dry crystals, which are chemically water “magnetic”, which means they will only accept water molecules into their structure. The crystals will expand to 500 times their own bulk in the presence of water.

To fit, remove the fuel filler cap and insert the cartridge into the tank securing the lanyard, the weighted cartridge rests on the bottom and extracts water from the fuel as it condenses. The cartridge should be checked at each re-fill and discarded when full.

Removing water from the fuel systems extends the life of filters, fuel pumps and injectors.

The safe and easy way to remove water from your fuel system.

For use in:

- Diesel
- Petrol
- Kerosene
- Fuel oil
- Hydraulic fluid
- Mineral spirits

1
2
3
4

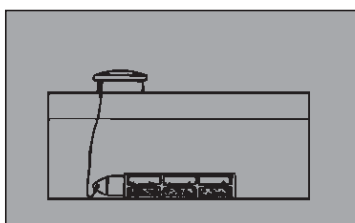
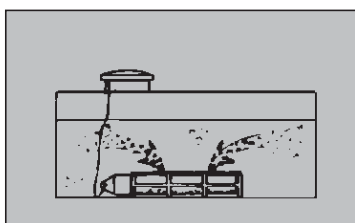
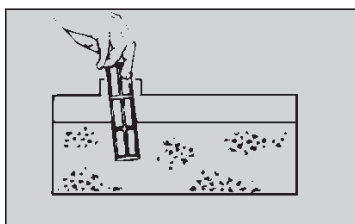
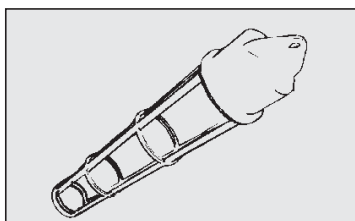

PRODUCT BENEFITS:

- Extended filter, pump and injector life
- Reduced maintenance costs
- Easy installation and safe disposal
- Trouble free efficient running





For all our latest catalogue updates and company info: www.tvh.be

DRY AIR FILTER - PLASTIC

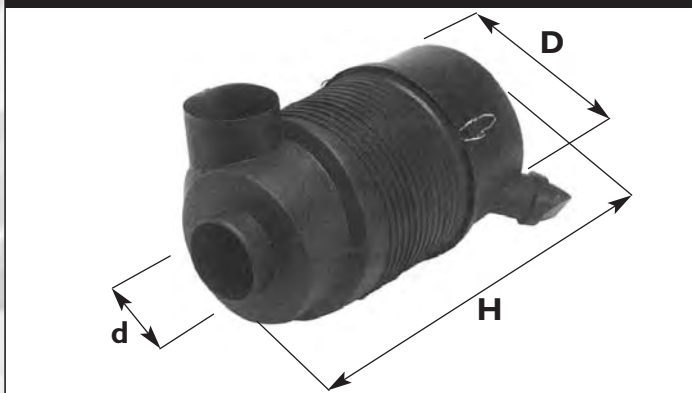

Dimensions D x d x H	Reference complete	Reference outer elem.	Reference inner elem.
type AW: (plastic)			
156 x 53 x 327 mm	107TA1760	107TA1757	106TA3037
196 x 78 x 360 mm	106TA3039	106TA3025	104TA8095
204 x 62 x 354 mm	107TA1761	106TA6947	
200 x 58 x 348 mm with 90° elbow	106TA3041	105TA4806	

DRY AIR FILTER - METAL

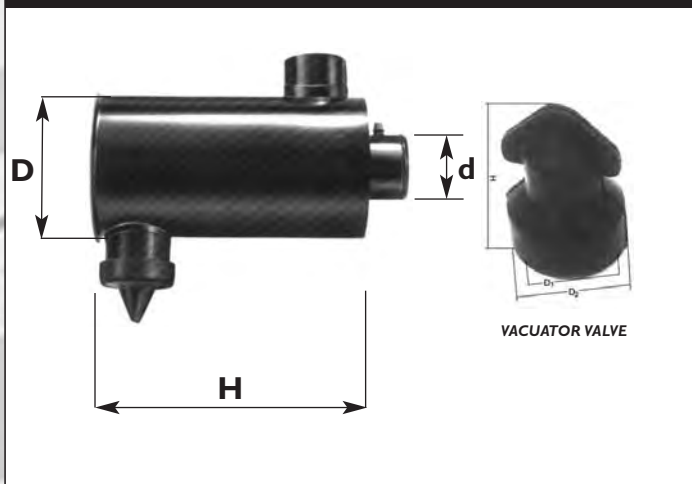

Dimensions D x d x H	Reference complete	Reference element
type AW: (metal)		
129 x 44 x 275 mm	106TA3026	106TA3012
138 x 50 x 330 mm	106TA3027	106TA3013
138 x 53 x 385 mm	106TA3028	106TA3013
167 x 60 x 355 mm	107TA1758	106TA3014
175 x 76 x 465 mm	106TA3030	106TA3015
178 x 79 x 360 mm	106TA3031	106TA3016 + 106TA3017
200 x 90 x 450 mm	106TA3032	106TA3018
208 x 76 x 435 mm	106TA3033	106TA3019
210 x 90 x 528 mm	106TA3034	106TA3020
242 x 102 x 540 mm	107TA1759	106TA3021 + 106TA3022
255 x 95 x 630 mm	106TA3036	106TA3023
VACUATOR VALVE		
REF./ 106TA2999	D=47, d=38, H=73	
REF./ 106TA3000	D=85, d=72, H=68	
REF./ 106TA3001	D=58, d=50, H=47	

RAIN CAPS / MOUNTING BANDS

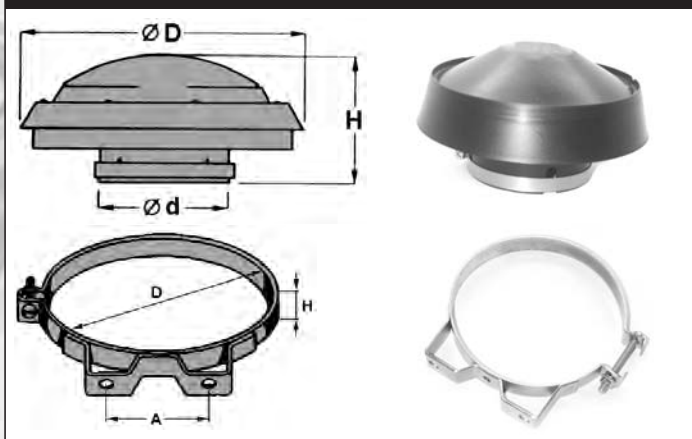

RAIN CAPS	
Dimensions D x d x H	Reference
150 x 57 x 85 mm	106TA2992
152 x 65 x 85 mm	106TA2993
152 x 78 x 85 mm	106TA2994
265 x 102 x 130 mm	106TA2995
268 x 128 x 130 mm	106TA2996
292 x 114 x 124 mm	107TA1755
408 x 155 x 158 mm	107TA1756
MOUNTING BANDS	
Dimensions D x H x A	Reference
131 x 22 x 93 mm	106TA3009
160 x 23 x 106 mm	106TA3010
197 x 26 x 117 mm	106TA3011

RESTRICTION INDICATORS



mbar	Pa	mm H2O	Fitting	Reference
Mechanic:				
37	3700	380	1/8"-27 NPT	106TA3002
50	5000	508	1/8"-27 NPT	106TA3003
62	6200	635	1/8"-27 NPT	106TA3004
Electric				
37	3700	380	1/8"-27 NPT	106TA3005
50	5000	508	1/8"-27 NPT	106TA3006
62	6200	635	1/8"-27 NPT	106TA3007
75	7500	762	1/8"-27 NPT	106TA3008



For all our latest catalogue updates and company info: www.tvh.be

FILTER KITS



PRODUCT SHOWN IS JUST A SELECTION OF FILTER KITS AVAILABLE. PLEASE CALL US WITH TRUCK MODEL AND SERIAL NUMBER AND WE GIVE YOU THE KIT NUMBER.

Example ref 500H means filter kit for 500 hours
 ref 1000H means filter kit for 1000 hours

FORKLIFT	ENGINE	OIL	FUEL	AIR	HYD	TRANS	REF/ 500H	REF/1000H
CATERPILLAR	XD3P	X	X	X			107TA1762	
VC60D (3FC1-UP) (3RBI-UP)		X	X	X	X	X		107TA1763 (HYD= 1"3/8) 107TA1760 (HYD= 1"1/8)
HYSTER	C240	X	X	X			107TA1764 CARTRIDGE 107TA1765 SPIN-ON	
H250XL		X	X	X	X	X		107TA1766 CARTRIDGE 107TA1767 SPIN-ON
KOMATSU	4D95S	X	X	X			107TA1768	
FD25-11E		X	X	X	X	X		107TA1769
LINDE	DEUTZ	X	X	X			107TA1770	
H25D-35I		X	X	X	X	X		107TA1771
MITSUBISHI	S4S	X	X	X			107TA1772	
FD25-18B		X	X	X	X	X		107TA1773
NISSAN	H20	X		X			107TA1774	
PH02		X		X	X	X		107TA1775
TCM	H20KA	X		X			107TA1776	
FG20N5		X		X	X	X		107TA1777 CARTRIDGE 107TA1778 SPIN-ON
TOYOTA	4Y	X		X			107TA1779	
42-6FG15		X			X	X		107TA1780



For all our latest catalogue updates and company info: www.tvh.be



HEAVY DUTY FILTERS - BELGIUM

**We supply
service filter kit
to your requirement.**



**see our list of filter kits available
on our webservices: www.tvh.be**

